

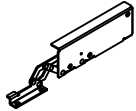









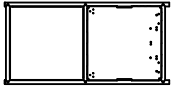
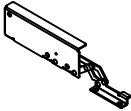

	①	2		(A)	2		(H) M4x12	24
	②	1		(B)	2		(I)	2
	③	12		(C) M4x25	12		(J)	2
	④	10		(D)	24		(K)	1
	⑤	2		(E) M6x45	12		(L) M4x8	8
				(F) M4	1		(M) M6x65	6
				(G)	6			

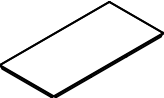
1

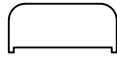
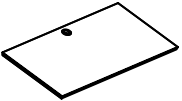

2

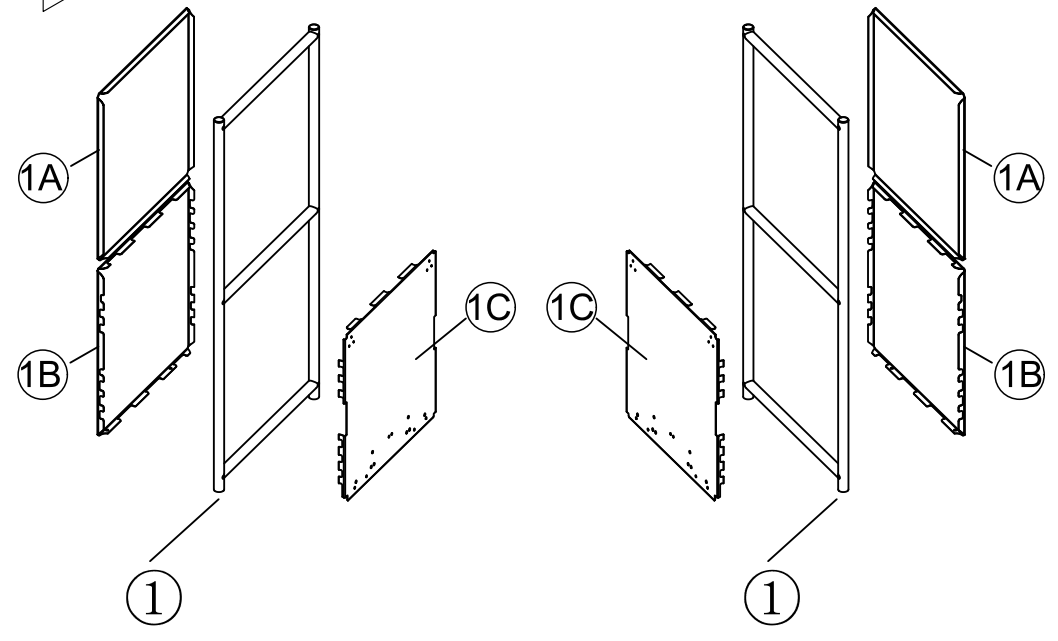
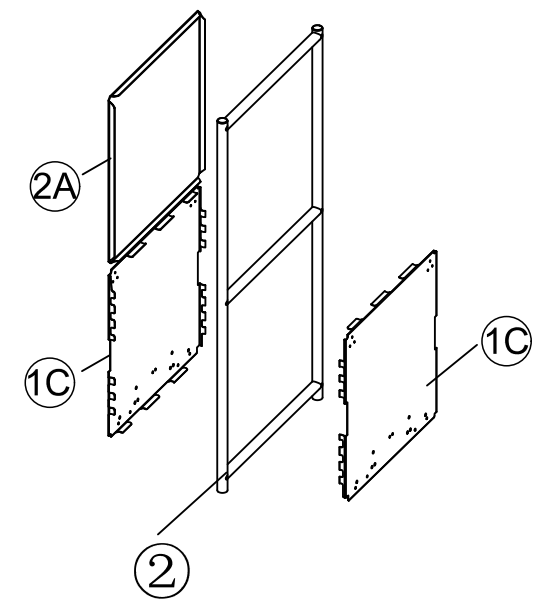

3

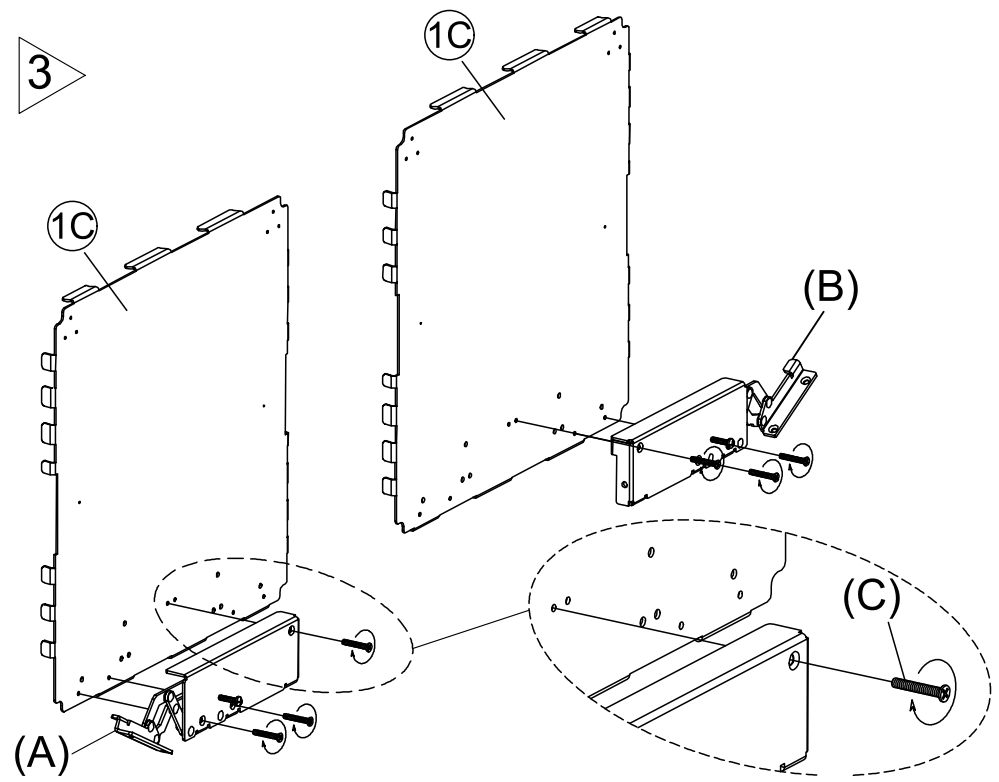

4

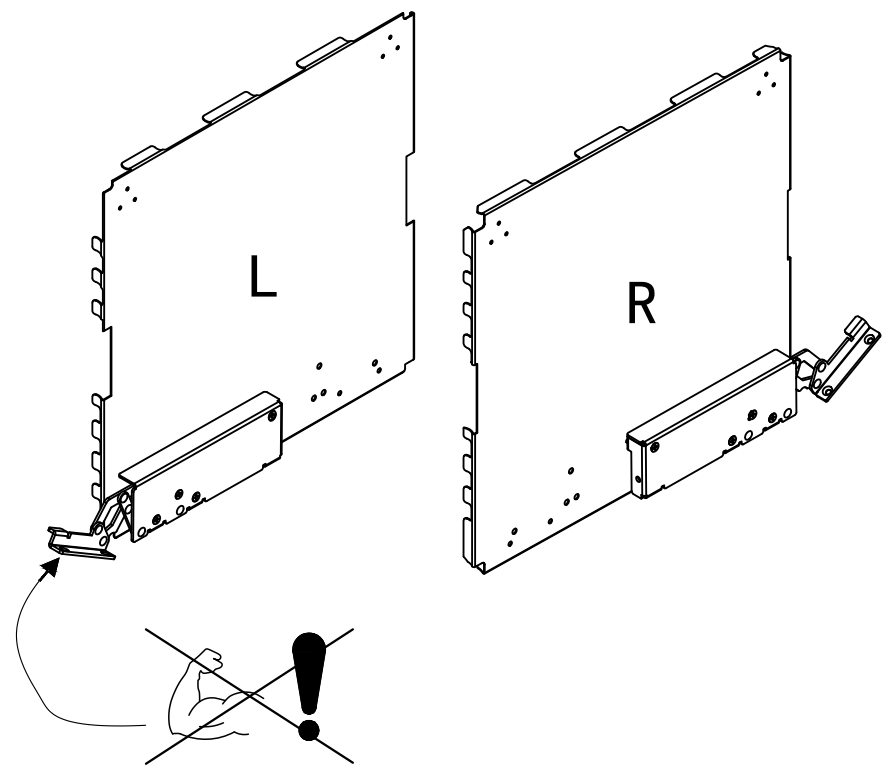

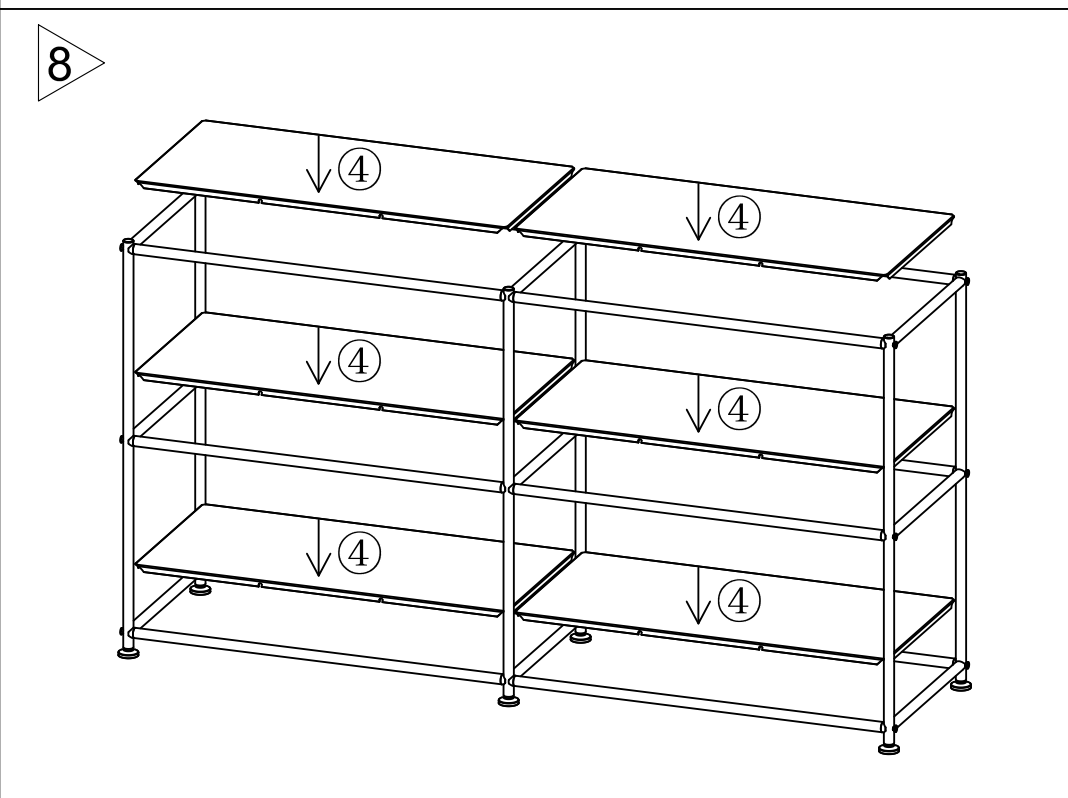
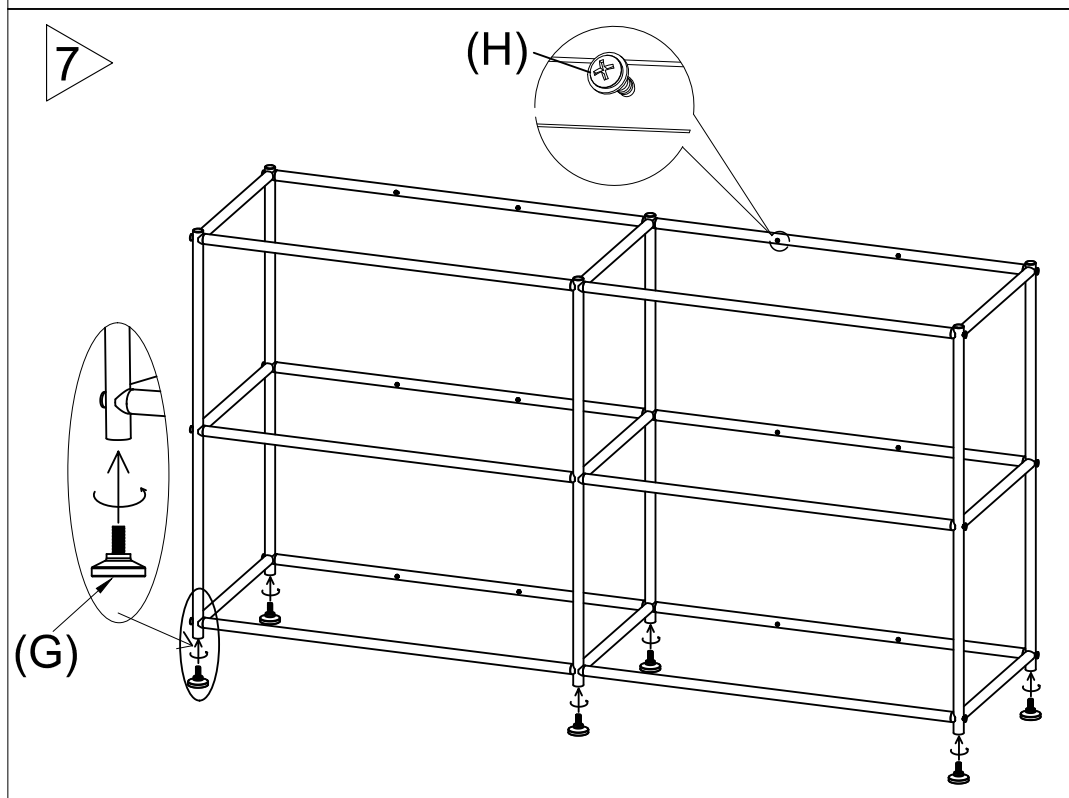
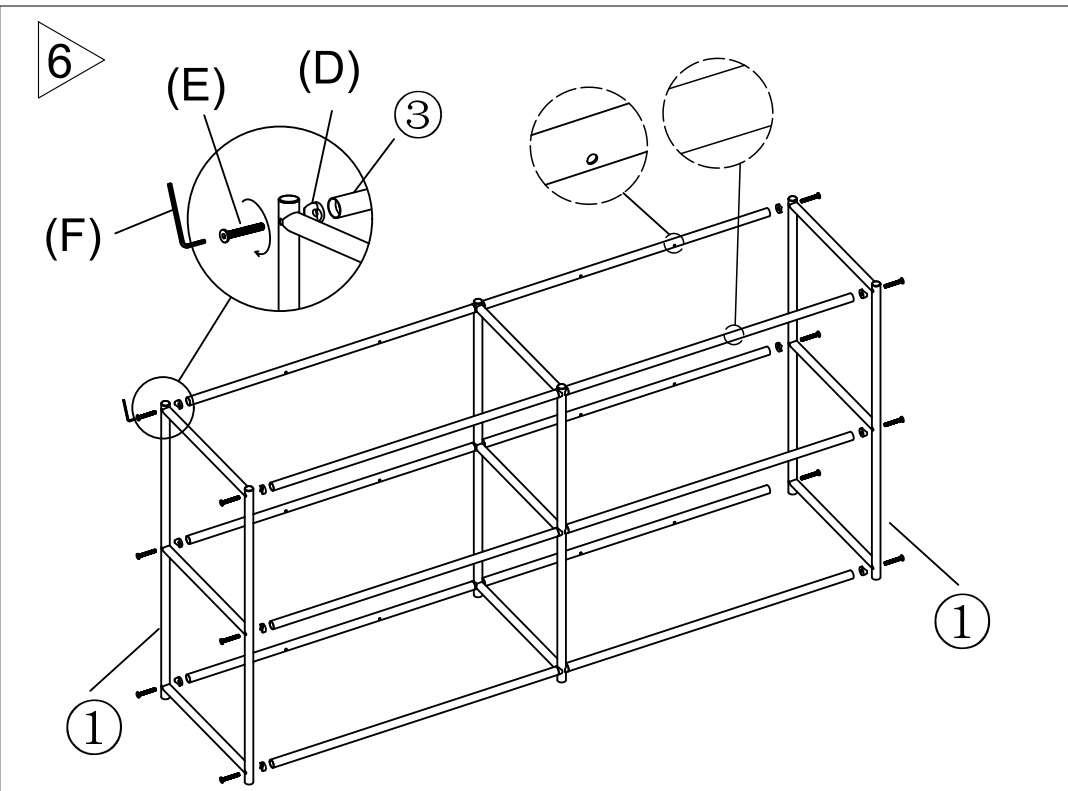
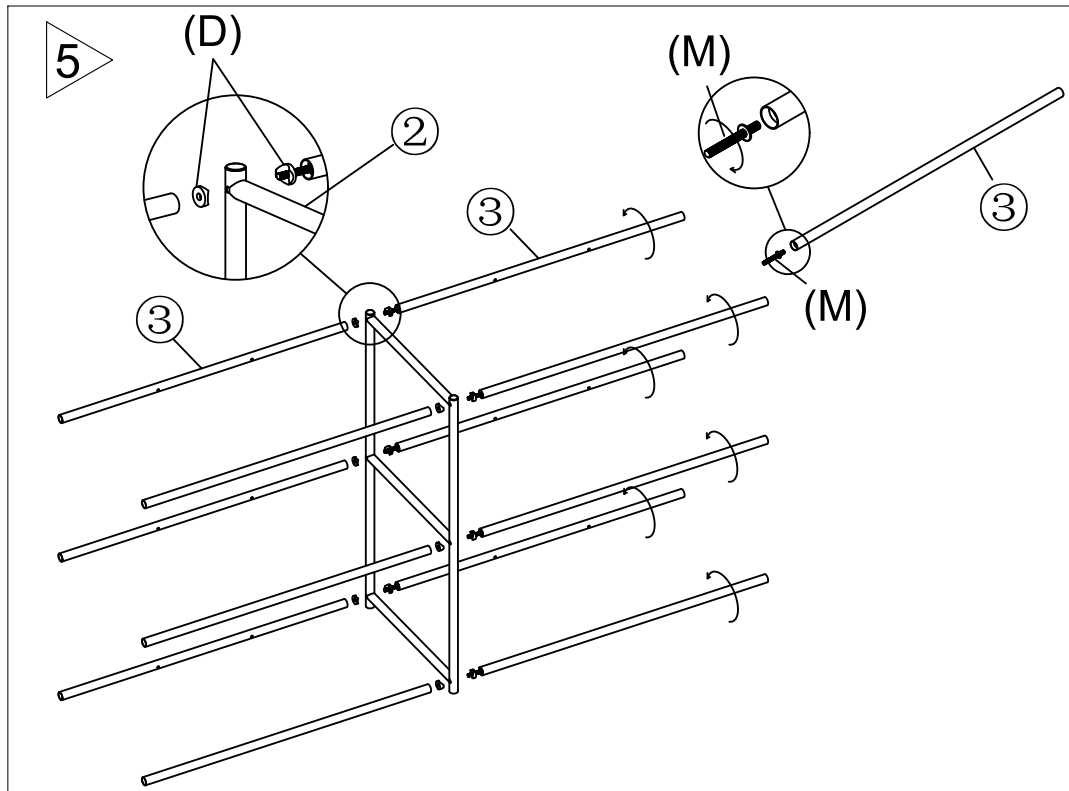

9

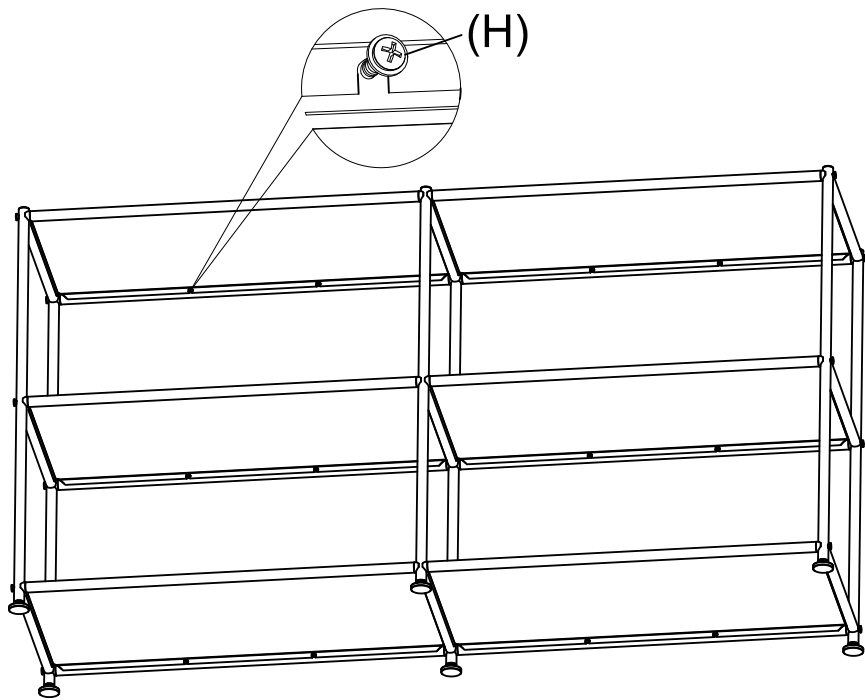

10

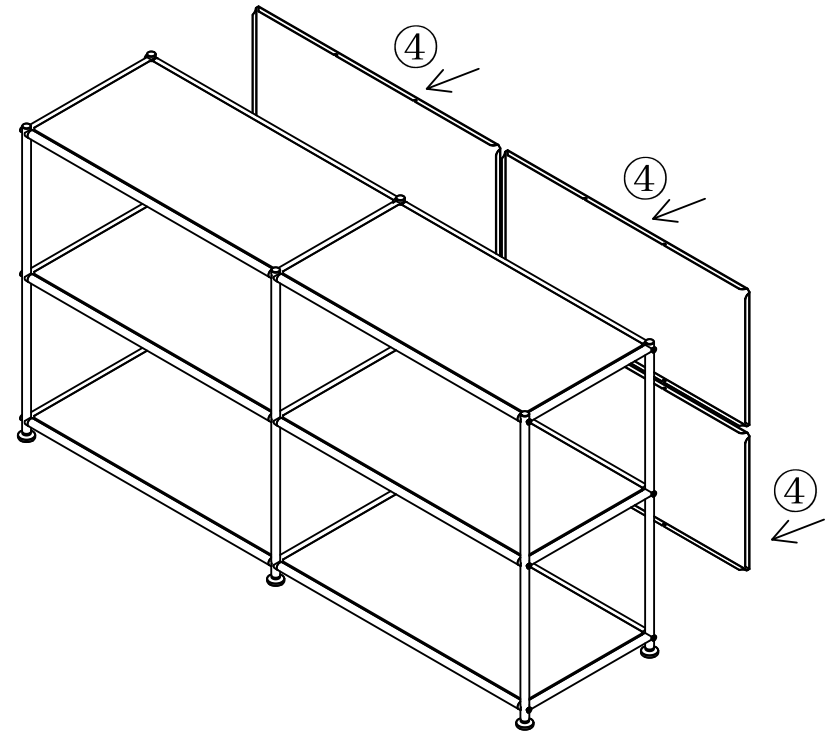

11

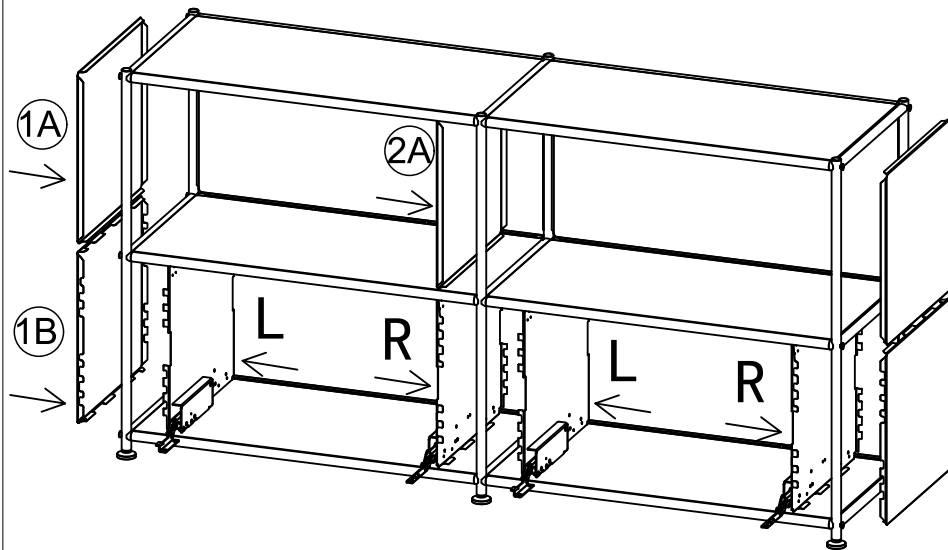

12

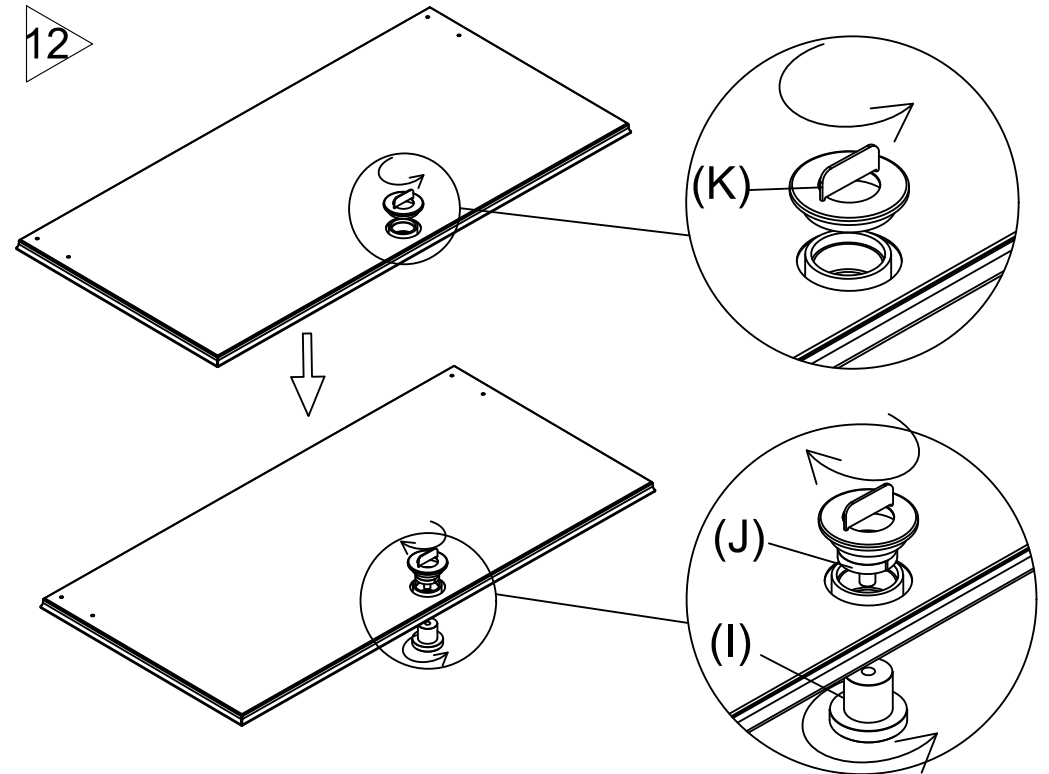

13

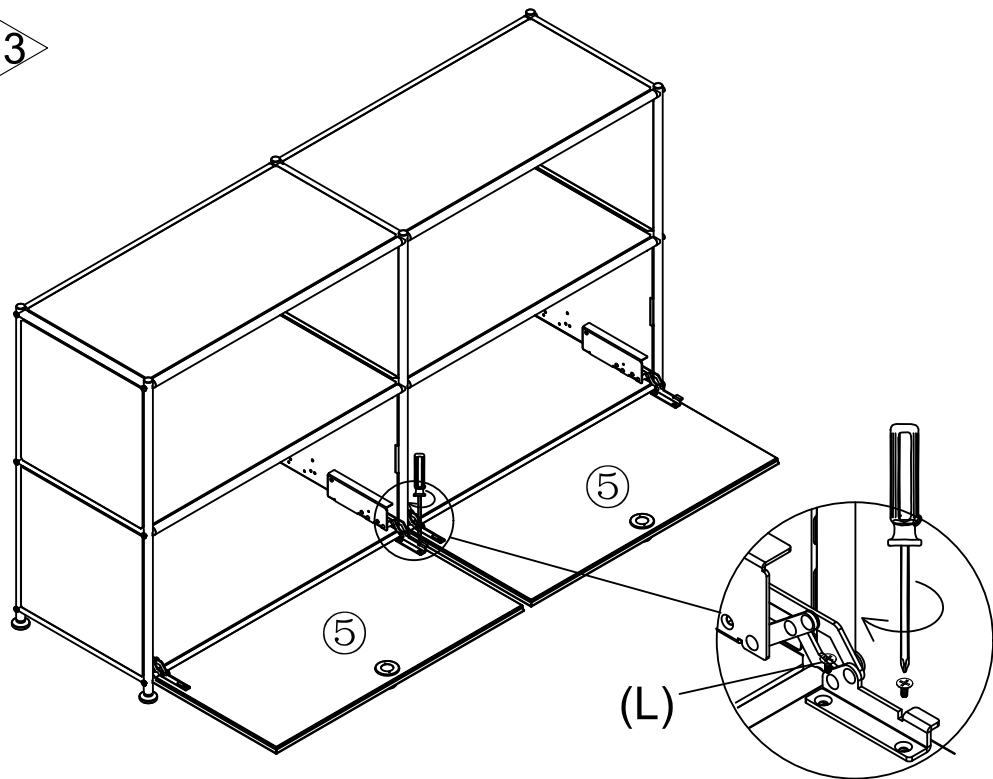

14

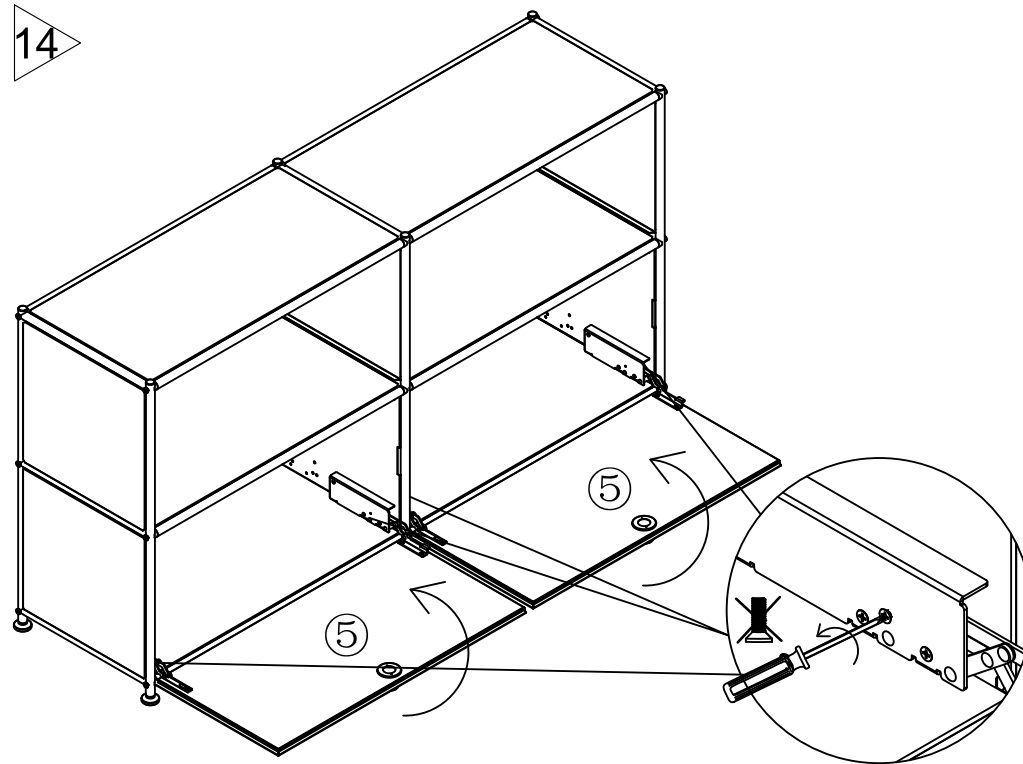

15

